

AUTOMOTIVE AIR CONDITIONER INSTALLATION INSTRUCTIONS

1957 Chevrolet Louver & Switch Package #093-00593

Items required, but not included are:
BASIC KIT #090-00432
-and-
WATER VALVE KIT #093-00592

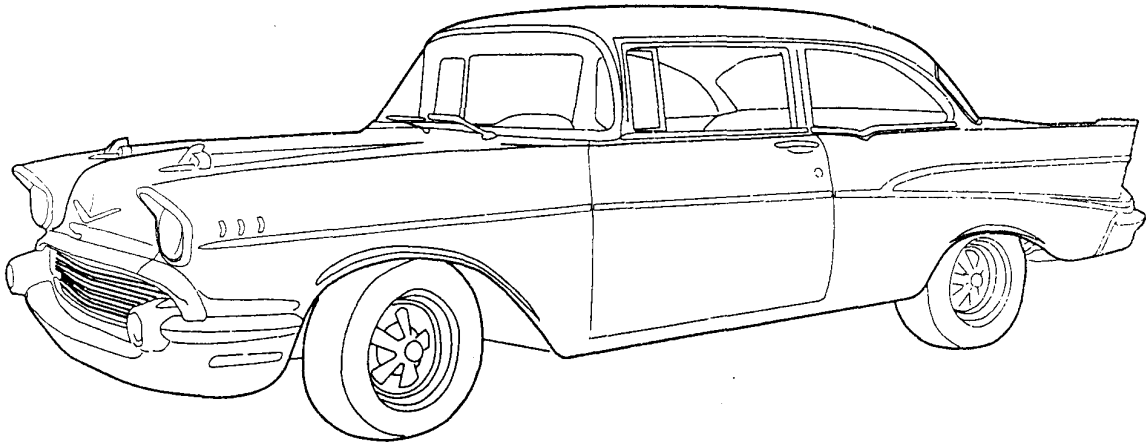

PN 057-00261

SPECIFICALLY DESIGNED FOR R-134a REFRIGERANT ONLY

6/00

1-800-275-7524/1-800-347-3883

IMPORTANT RESTRICTION

THE INFORMATION CONTAINED HEREIN IS FOR EXCLUSIVE USE OF THE MANUFACTURERS CUSTOMERS. NEITHER THE SHEETS NOR THE INFORMATION CONTAINED THEREIN ARE TO BE COPIED OR REPRODUCED WITHOUT THE PRIOR WRITTEN CONSENT OF THE MANUFACTURER. ALL RIGHTS WHICH THE MANUFACTURER HAS OR OBTAINED THEREIN, INCLUDING PATENT RIGHTS ARE EXPRESSLY RESERVED BY THE MANUFACTURER.

IMPORTANT NOTICE

IF AN INSTALLATION IS MADE ON ANOTHER VEHICLE OTHER THAN SPECIFIED, THE FACTORY WILL NOT INCUR ANY EXPENSE FOR LABOR, TIME AND MACHINE EXPENSE TO MAKE THAT PARTICULAR INSTALLATION. ANY DEVIATION FROM PRODUCT DESIGN COMPONENT OR THE USE OF OTHER MATERIAL PARTS AND/OR SYSTEM COMPONENTS WILL BE WITH THE INSTALLER'S RESPONSIBILITY FOR ANY SUCH CHANGE OR DEVIATION.

MADE IN U.S.A.

CAUTION

Before beginning this installation, take a few minutes to pre-read these instructions. Check that all necessary materials, units and accessory kits that are listed in the application guide are on hand. It is imperative for proper engine operation and vehicle life that adequate engine cooling is provided (i.e. fan shroud and/or large fan). Also check the vehicle weight capacity as listed on the vehicle certification label. Advice is hereby given by the vehicle manufacturer that for proper driving and handling, the reserve weight capacity not be exceeded, refer to the manufacturer recommended sizing guide.

RECOMMENDED STANDARD TORQUE SPECIFICATIONS FOR STANDARD FITTINGS

O-RING CONNECTIONS		
TUBE O.D.	THREAD SIZE	FT./LB.
1/4"	7/16"	5-7
3/8"	5/8"	11-13
3/8	11/16"	11-13
1/2"	3/4"	15-20
5/8"	7/8"	21-27
3/4"	1-1 / 16"	28-33

NOTES

Unless otherwise specified, all instructions are given from the driver's seat position facing forward with the engine radiator being the front or forward direction of vehicle.

IMPORTANT: Automotive air conditioning installation requires a basic knowledge of refrigeration systems and services of a qualified mechanic. These instructions explain the steps necessary for the installation of this unit but do not detail standard workshop procedures or safety practices.

NOTE: For the air conditioner to operate properly, it must not contain moisture or dirt particles. Leave all protective caps in place until final installation of the component. Use clean Refrigerant Oil on all thread and sealing surfaces when making fitting connections. Use a backup wrench to avoid twisting fittings.

NOTICE: Automotive air conditioners operate under high pressures and utilize a refrigerant that can be dangerous if not handled properly. Installation, service and repairs should be performed only by those individuals who possess the mechanical skills required and have a basic understanding of refrigeration systems and their operation and who are familiar with and follow approved safety procedures.

CAUTION: Before starting installation, open hood and disconnect the NEGATIVE (-) GROUND side of battery cable. Install protective fender covers to prevent paint scratches.

Installation Instructions 1957 Chevrolet

This unit is designed to replace the original cable controls with electronic and vacuum operated controls. Before starting the installation, check the function of the vehicle horn, lights, windshield wipers for proper operation. Read and study the instructions and wiring diagram, before starting the installation.

UNDER HOOD

1. Raise hood, disconnect the battery.
2. Drain radiator, disconnect heater hoses at firewall, remove heater cover.

PASSENGER INSIDE

3. Remove the OE Control panel and disconnect cables.
4. Remove and discard the glove box.
5. Remove screws from vent cable (passenger side) if equipped.
6. Remove and retain glove box door.
7. Remove and discard OE:
(FIGURE 1)
 - Defroster Duct
 - Heater Duct
 - Heater Assembly

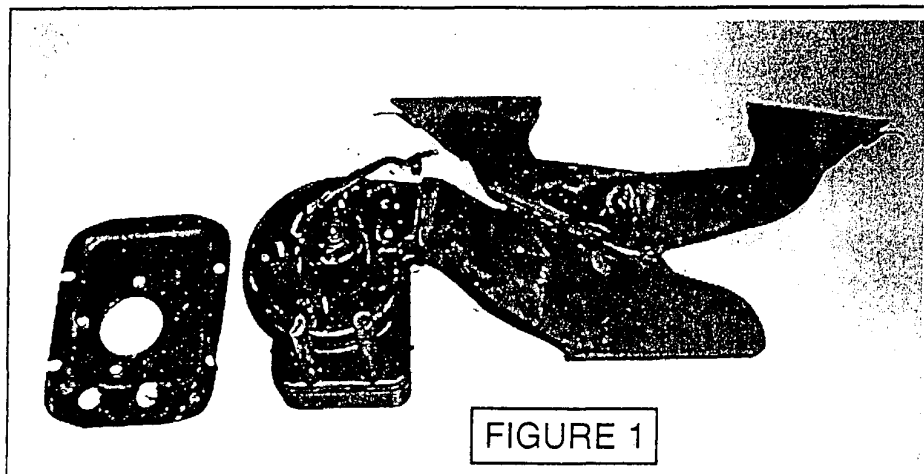

8. Locate OE Hole, mid-center, of firewall. Mark and drill a 1/4" diameter hole 1.50" directly below it. (FIGURE 2)
9. From engine side of firewall, install support bracket with weld studs.
10. Secure the driver side evaporator mounting bracket to studs with hardware provided. (FIGURE 2)

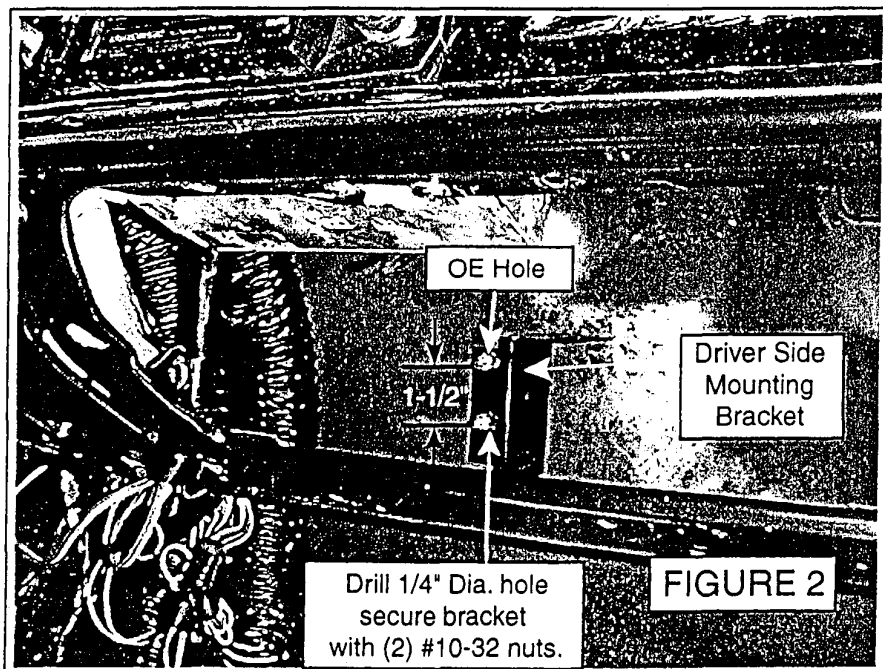

11. Secure the passenger side evaporator mounting bracket to the blower mounting bracket with hardware provided.

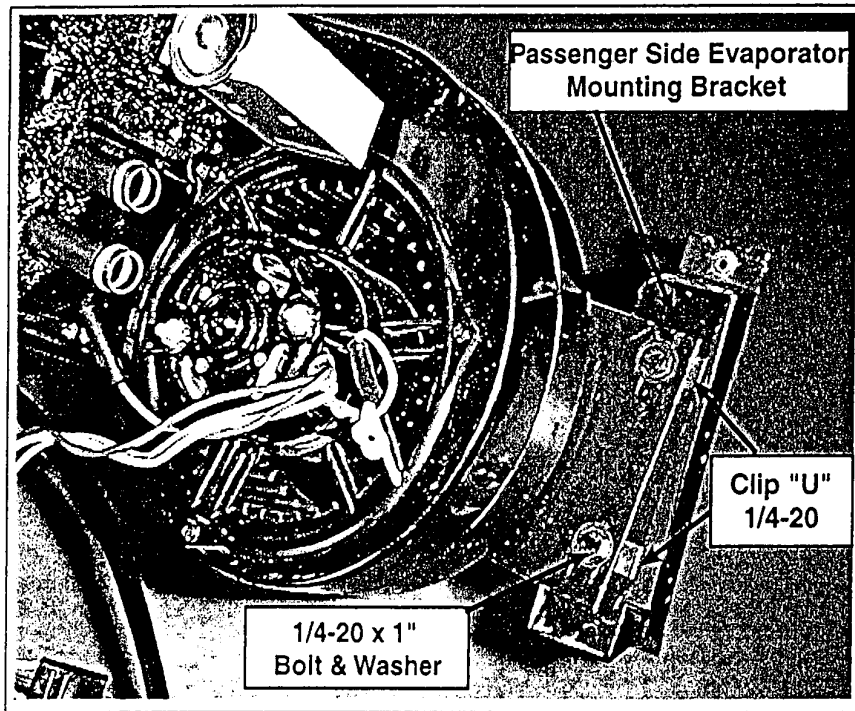

FIGURE 3

12. Temporarily install the evaporator into position desired, be sure evaporator is horizontal to bottom of dash. Secure the passenger side evaporator mounting bracket to firewall with hardware provided. (FIGURE 4)
13. Remove the evaporator, remove the passenger side evaporator mounting bracket.

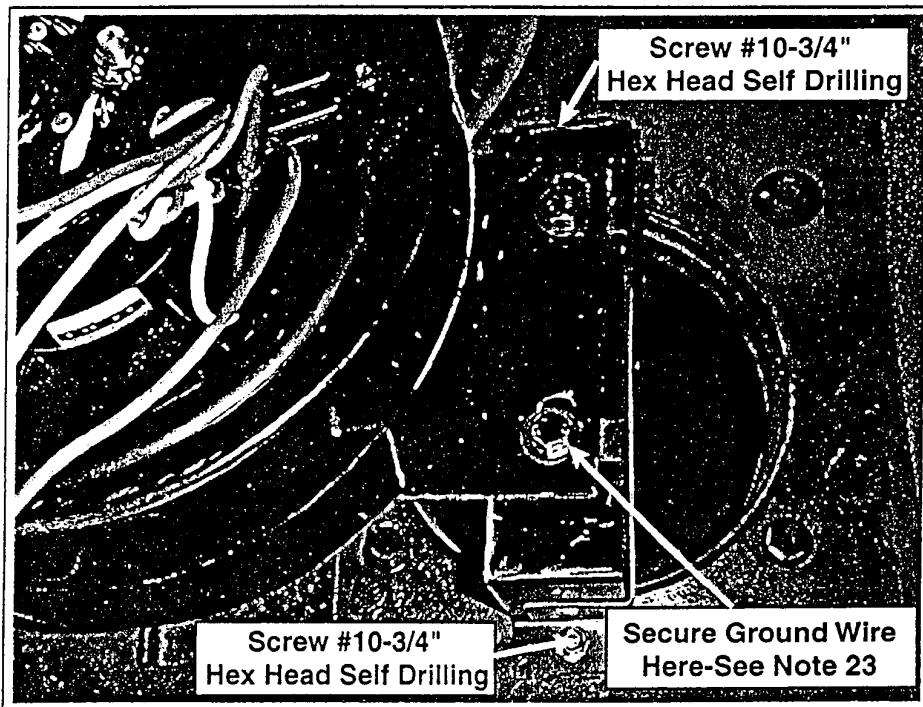

FIGURE 4

14. Secure the vacuum solenoid valves to the passenger side mounting brackets with hardware provided cut and secure vacuum hose to vacuum valves (as shown) reinstall passenger side mounting bracket. (FIGURE 5 & 6)

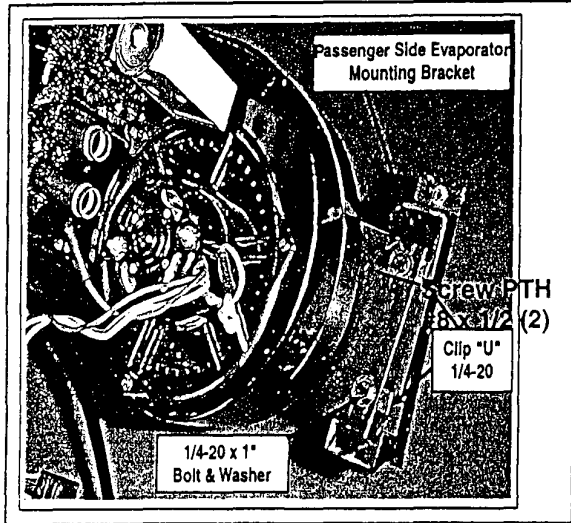

FIGURE 5

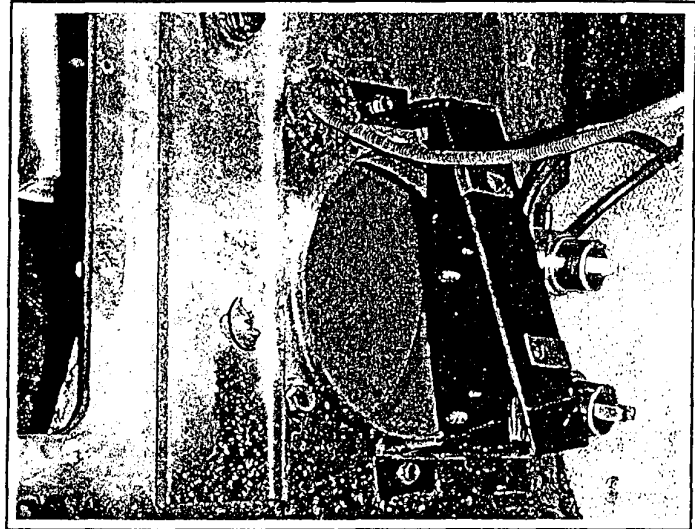

FIGURE 6

15. Obtain defrost ducts, secure 2" flex hose with hardware provided. Drivers side defrost duct length - 22". Passengers side defrost duct length - 16".
16. Install defrost ducts, secure with hardware provided. (FIGURE 7 & 8)

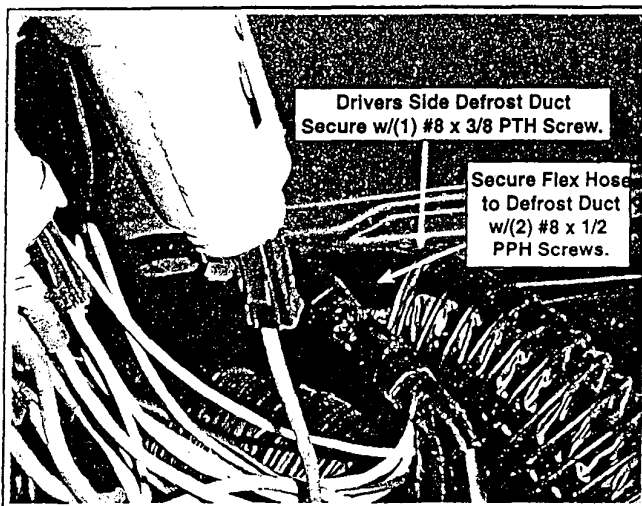

FIGURE 7

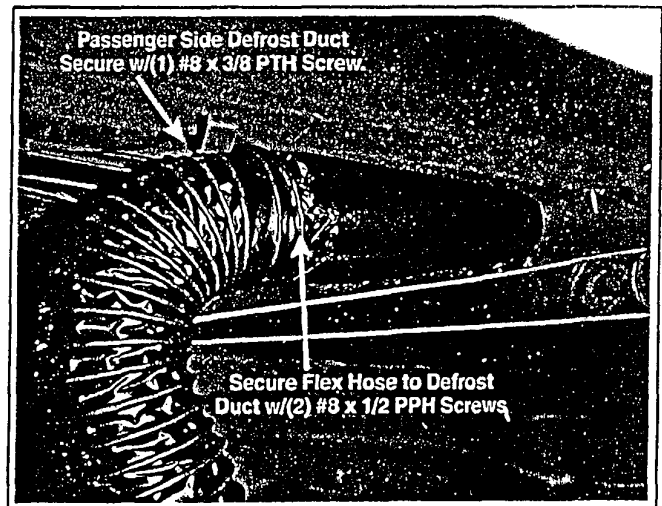
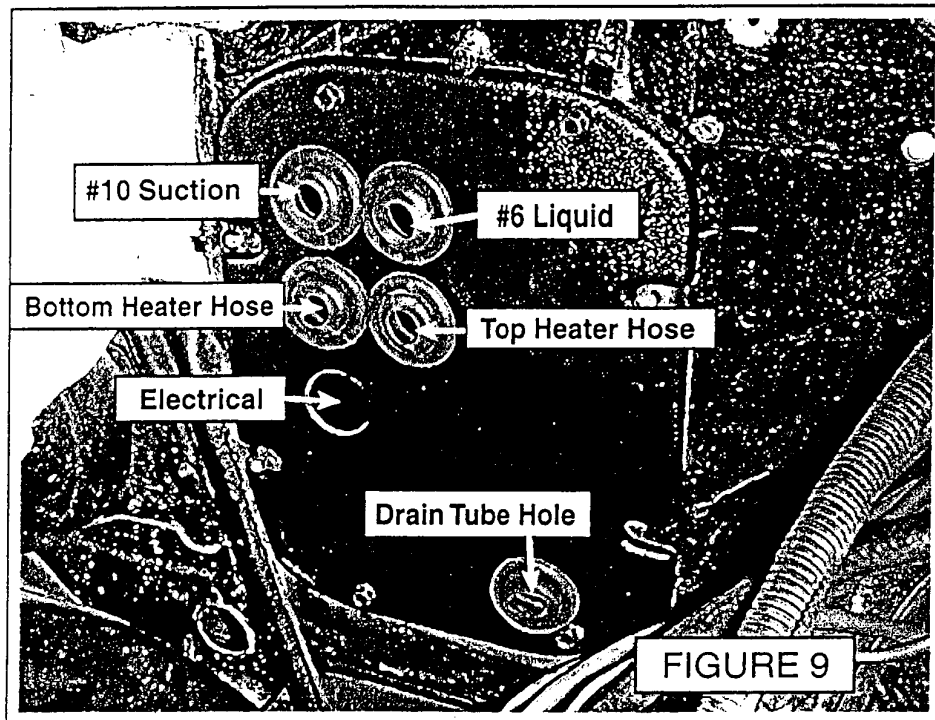

FIGURE 8

17. Obtain firewall cover, install grommets.
18. Run a bead of silicone around the perimeter of the firewall cover and install it over the four (4) studs on the firewall, secure with OE sliding clamps or hardware provided. (FIGURE 9)



19. Refrigerant fittings and hoses are not supplied in this kit. Obtain proper fittings and connect to the block type expansion valve.
20. Secure 5/8" heater hose to the heater fittings on the coil. Identify the opposite end of the bottom heater hose so it can be secured to the outlet or intake manifold at a later time. (FIGURE 10)

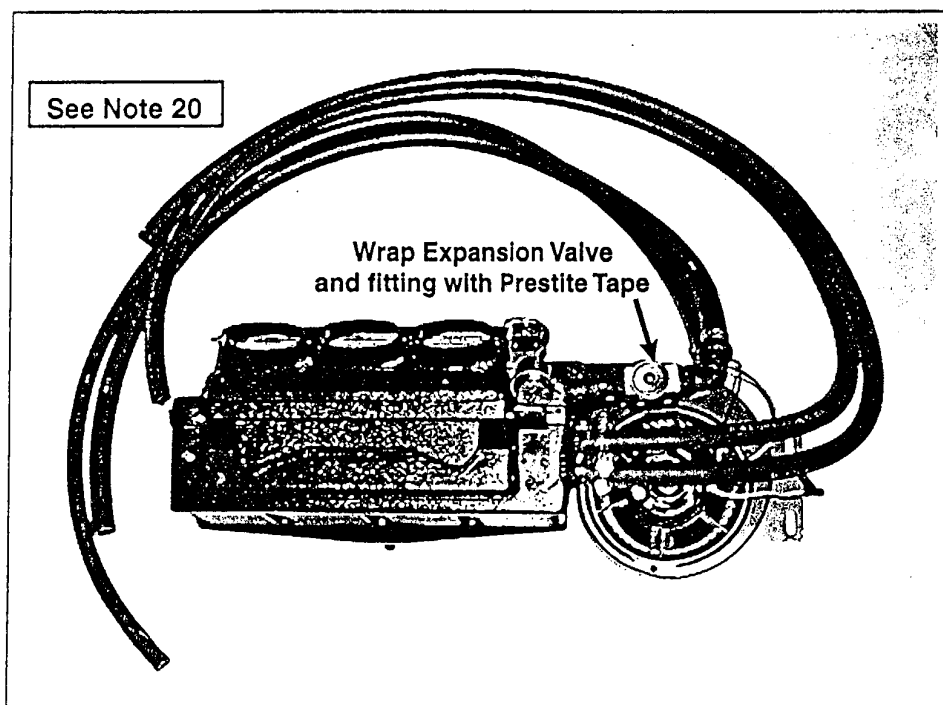

FIGURE 10

21. Lay the evaporator assembly with hoses in the passenger side floor board, route hoses thru the firewall cover plate and pull hoses thru the cover to allow evaporator to be pulled into position.
22. Secure the evaporator to both evaporator mounting brackets. **NOTE:** Evaporator must be tilted slightly to ensure proper drainage.
23. From engine side of firewall, feed wire harness thru bottom hole of cover and run to control panel area. Secure wires to vacuum solenoids, blower plug and ground wire. Ground the black ring terminal to blower mounting bracket using one of the existing 1/4-20 mounting bolts. (FIGURE 4)
24. Obtain the control assembly. Route the thermostat capillary tube to the evaporator and insert into opening in the top center of the case top. (Approx. 3") caution be careful not to break or kink the capillary tube. (FIGURE 11)

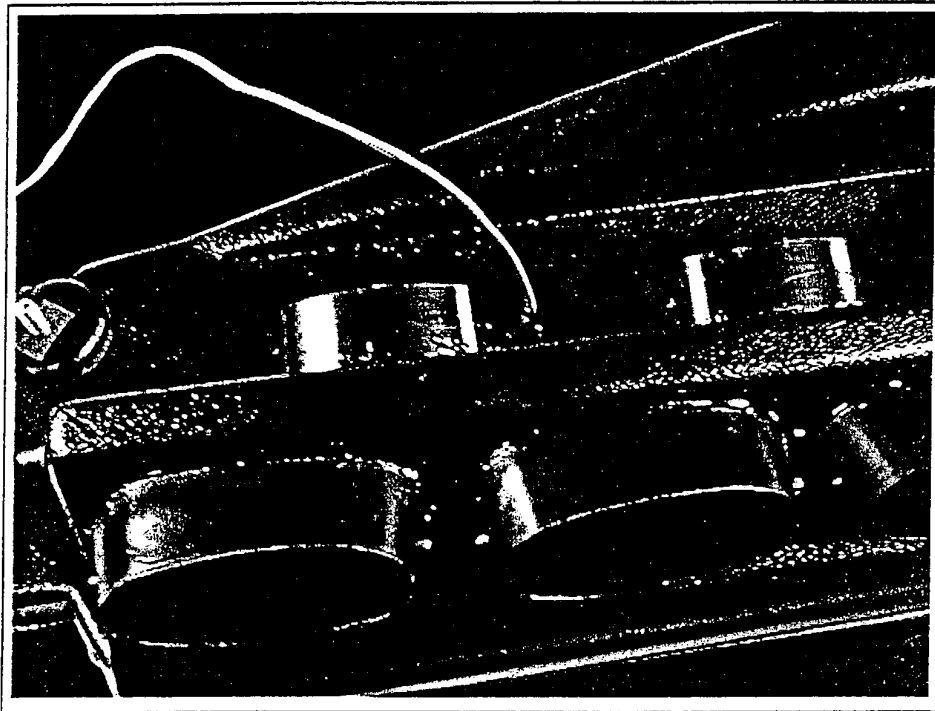

FIGURE 11

25. Obtain the side panel louvers and the center louver, secure the 2-1/2" flex hose to each louver (as shown) and secure into position with hardware provided. (FIGURE 12)

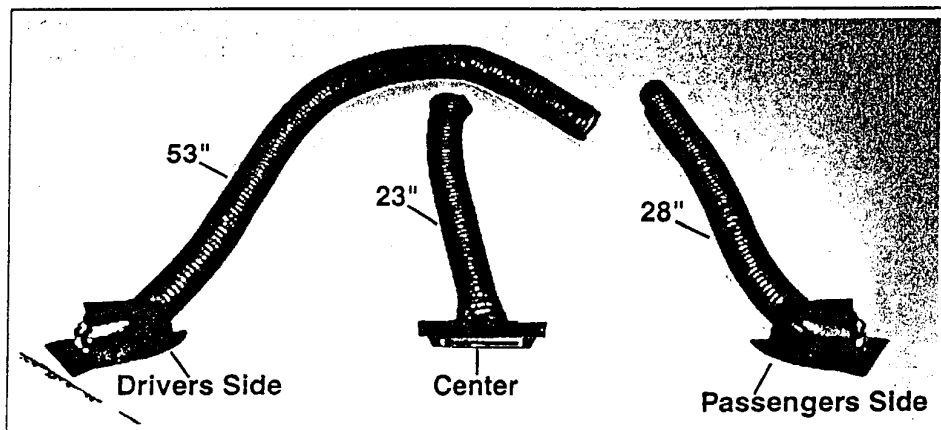

FIGURE 12

26. Connect the wire harness to the control assembly. Secure control assembly to dash with original hardware.
27. Secure 2" defrost duct hoses and 2-1/2" louver duct hoses to the evaporator. (FIGURE 13)

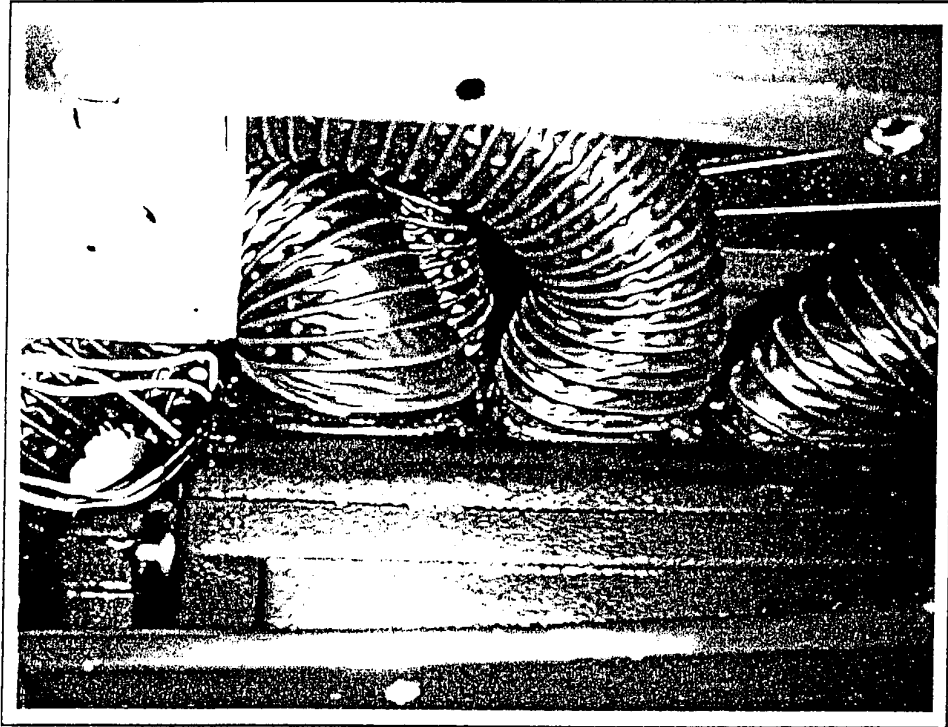

FIGURE 13

28. Install drain hose. Using two (2) 90° elbow fittings.
29. Secure speed nuts to new glove box. (FIGURE 14)

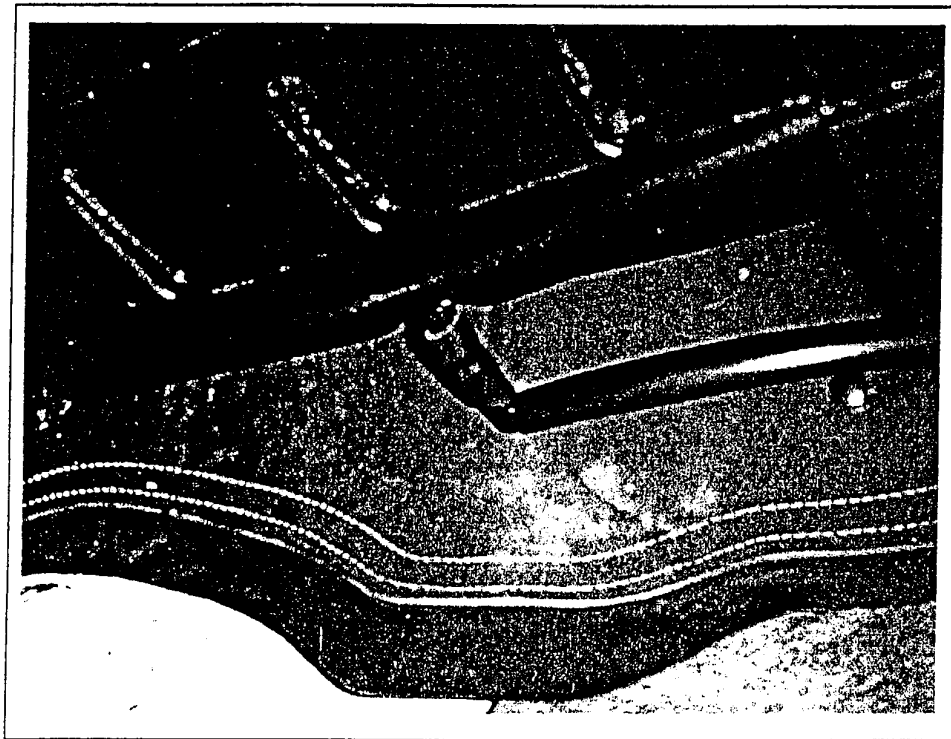
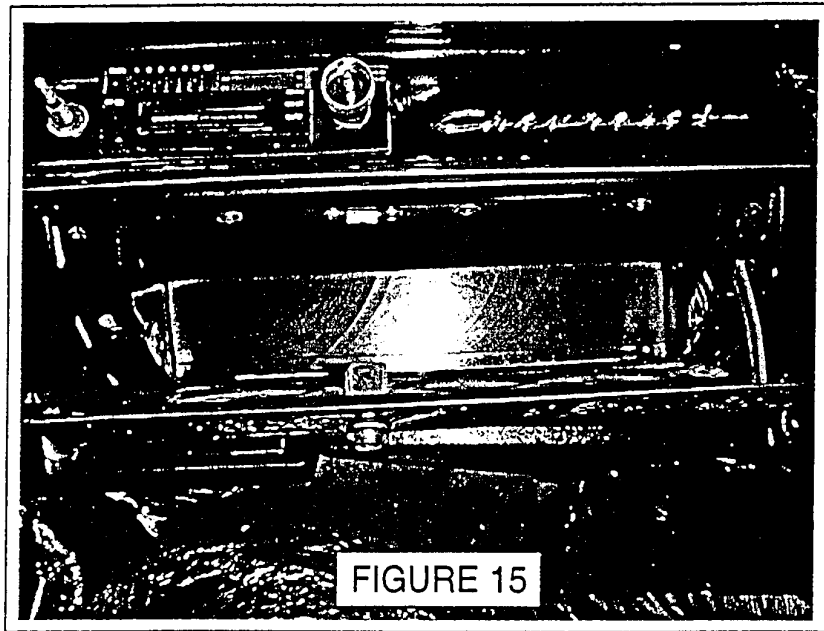

FIGURE 14



- 30. Install glove box door.
- 31. Secure evaporator blower cover. (FIGURE 15)

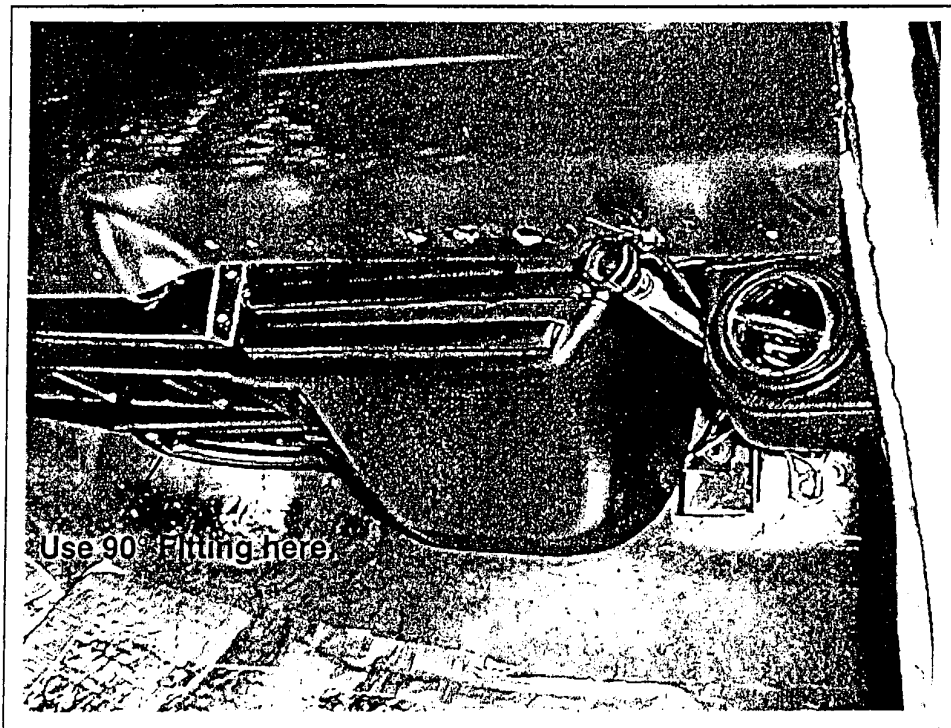
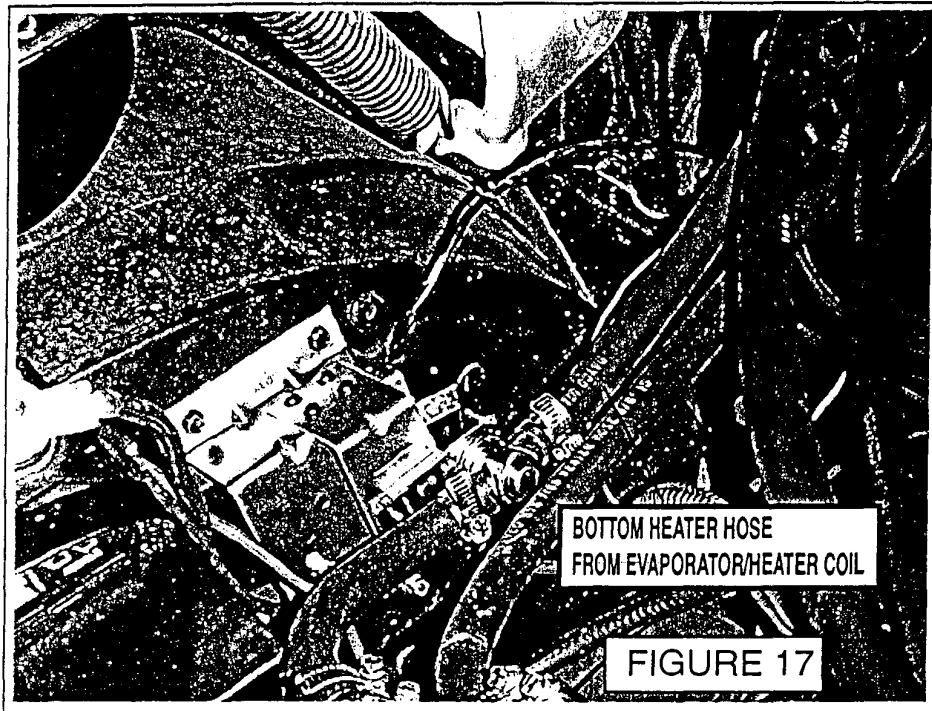

FIGURE 16

UNDER HOOD

32. Mount the electric water valve to the passengers side fender weld with hardware provided. (Note arrow on direction of flow on the water valve.) **Caution:** If installed incorrectly it will cause damage to the water valve and cause it to leak. This will result in A/C not cooling properly. (FIGURE 17)



33. Secure round fresh air cover to fresh air vent. (FIGURE 18)

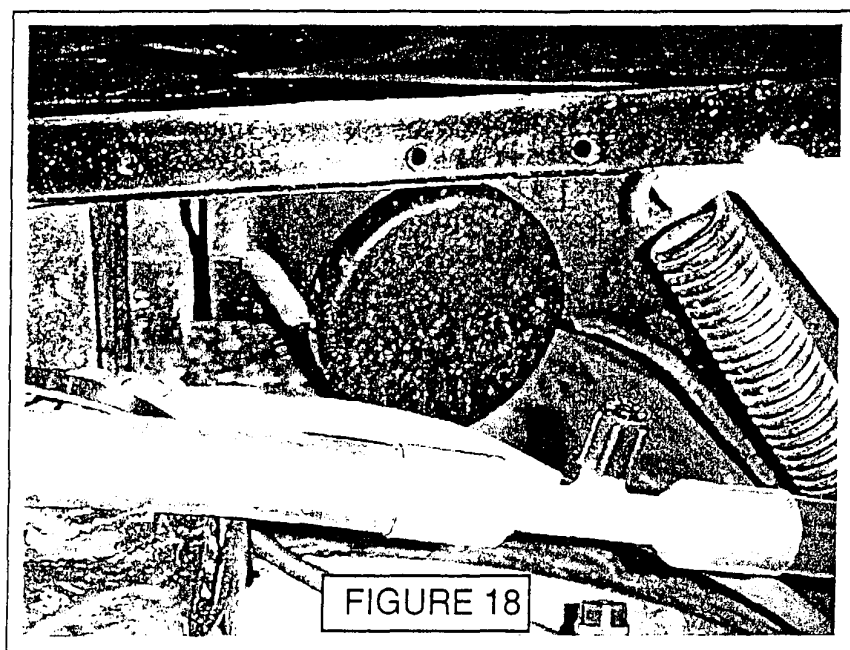

WIRING DIAGRAM

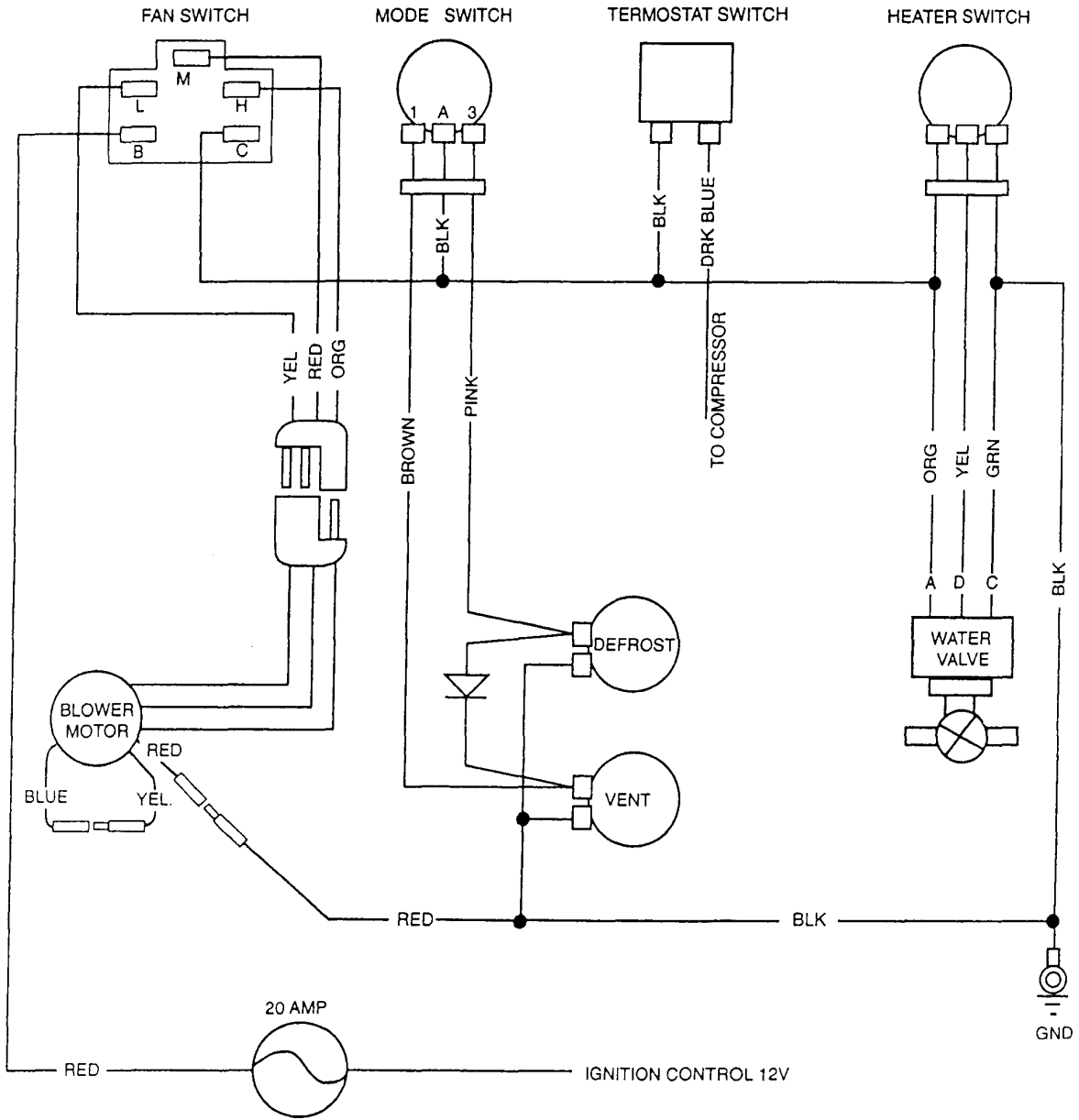

VACUUM DIAGRAM

